



VLA1G8 Undercounter Dishwasher
502736 - Undercounter Dishwasher and Glasswasher,
Atmospheric boiler, Energy Star 2.0,
30 racks/hour - 208V/1N/60Hz

Ideal for: Bars and small restaurants.
Fast, Reliable and Easy to operate. Peace-of-mind technical design

Characteristics and Advantages:

- Fully automatic self-cleaning cycle avoids the risk of bacteria proliferation.
- State-of-the-art electronic controls with built-in programming, self-diagnostics for serviceability and automatic interior self-cleaning cycle.
- Built-in atmospheric boiler sized to raise incoming water to 183.2 °F minimum for sanitizing rinse. No external booster is required.
- 4 second (variable) pause after washing and before rinsing ensures that no drops of unclean water will fall on the clean items at the end of the rinsing cycle.
- Constant temperature of 183.2 °F throughout the rinsing cycle regardless of the network's water pressure and temperature.
- Built-in rinse aid and detergent dispenser with automatic initial and continuous cycle loading for perfect result while minimizing service and maintenance needs.
- Digital read-out keeps operator informed as to temperatures.
- Double skinned insulated wall ensures a low noise level and a reduction in heat loss from the machine.
- High efficiency air gap (class A) in water inlet circuit to avoid water being siphoned back into the network as a result of a sudden drop in main pressures.
- IPx4 water protection.
- Low noise level.
- Three phase or single phase electrical connection, convertible on-site.
- Unique temperature interlock guarantees required temperatures in both the wash and final rinse.
- Washing capacity of 30 baskets or 540 dishes per hour.
- Washing system endowed with rotating washing arms, high powered wash pump and large capacity boiler for professional washing.
- Simple control panel with digital display allows on-site personalization of washing and rinsing cycle times and temperatures as well as precise rinse aid and detergent quantities to suit customer's needs.
- Simple service from the front.
- Pre-arrangement for HACCP system implementation and Energy Management device.
- Slanted wash arms to avoid detergent-filled wash water dropping on clean dishes after the rinsing phase, thus guaranteeing ideal washing results.
- An effective rinse system uses only 0.66 gal of clean hot water per basket for lower running costs.





Construction

- Unit to feature smooth surfaces to facilitate cleaning.
- Incorporated drain pump to control water level in wash tank draining.
- Large tank filter collects the soil to keep the wash water clean for a longer time and have better washing performance.
- Element protection from dry fire and low water.
- Large deep drawn wash tank and internal wash area with round corners and no pipes to avoid dirt built-up.
- Revolving Stainless steel wash/rinse arms above and below the basket.
- The boiler drain facilitates the evacuation of stagnant water after long periods of inactivity to ensure a higher level of hygiene.
- 304 stainless steel boiler with higher welding protection to increase resistance to corrosion.
- Completely closed on the back by a cover plate.
- Insulated double skin door construction preserves heat inside the tank to lower energy consumption and the noise. Counter-balance mechanism minimizes impact when opening and closing.
- Unit to feature drain pump, rinse aid and detergent dispenser pumps.
- Front panel, door, wash tank, tank filters, wash arms and rinse arms made in heavy duty anti-corrosive 304 AISI stainless steel.

Included Accessories

- 2 of Yellow cutlery container
- 1 of Basket for 18 dinner plates 9.5 inch yellow
- 1 of Basket for 48 small cups/24 cups blue

Optional Accessories

- Stand for undercounter dishwasher PNC 860418
- Kit 4 castors for double skin undercounter dishwashers PNC 864008



VLA1G8 Undercounter Dishwasher

502736 - Undercounter Dishwasher and Glasswasher, Atmospheric boiler, Energy Star 2.0, 30 racks/hour - 208V/1N/60Hz

Electric

Supply voltage:	208 V/1 ph/60 Hz, convertible to 208 V 20A 3~ MOP 30A
502736 (VLA1G8)	
Default Installed Power:	6.85 kW
Boiler heating elements:	6 kW
Tank heating elements:	2.2 kW
Wash pump size:	1 hp (0.736 kW)

Water:

Pressure, bar min/max:	0.5-7 bar
Water supply temperature*:	50-122 °F
Drain line size:	1/2 inches
Inlet Water supply pressure:	7 - 102 psi (0.5 - 7 bar)
Washing tank capacity (gal):	6.07 gal
Water consumption per cycle (gal):	0.6 gal
Boiler Capacity (gal):	3.17 gal

Key Information:

Baskets per hour*:	30
Dishes per hour:	540
Working cycles time (sec.):	120/240
Wash temperature:	154.4 °F
Cell dimensions - width:	19.68 inches
Cell dimensions - depth:	19.68 inches
Cell dimensions - height:	13.18 inches
Rinse temperature:	183.2 °F
External dimensions, Width:	23.62 inches
External dimensions, Height:	32.25 inches
External dimensions, Depth:	26.62 inches
Packaging size (WxDxH):	23.62 x 24.09 x 33.46 inches
Noise level:	61 dBA

* According to market standard, the productivity is declared at an inlet water supply temperature of 122 °F.

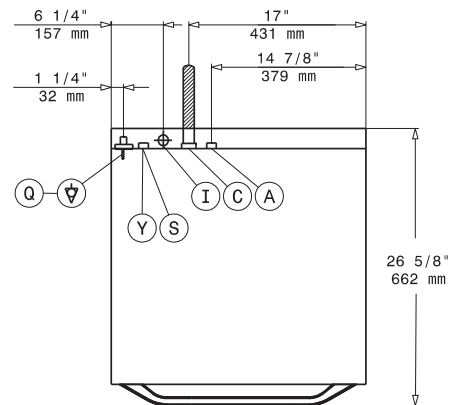
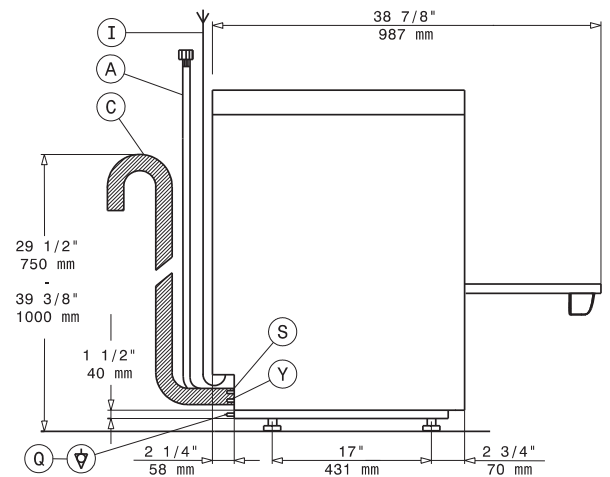
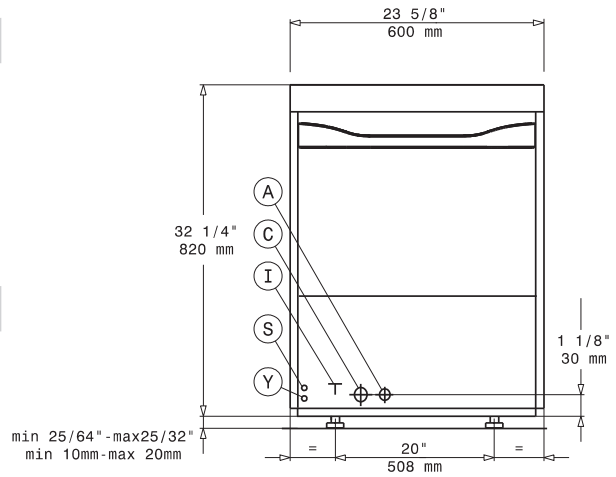

- D Drain
- EI Electric inlet (power)
- EO Electric Outlet
- HWI Hot water inlet
- XD Detergent connection
- XR Rinse aid connection