

**Refrigeration Equipment
Merchandiser Refrigerator, 12
cu.ft - 1 Glass Door, black (R290)**

ITEM # _____

MODEL # _____

NAME # _____

SIS # _____

AIA # _____



738247 (KCHGM12R)

1-glass door merchandiser refrigerator, black, 12 cubic feet, R290 refrigerant gas, +33/+41°F

Short Form Specification

Item No. _____

1-glass door refrigerator with exterior back and bottom panel in galvanized steel, exterior side and top in painted steel; interior back, side top and bottom panels in 304 stainless steel.
Electronic control.

R290 gas in refrigeration circuit.
ETL Safety and Sanitation certified.
3/5 Years warranty.

Main Features

- External temperature display.
- Removable door gasket for easy cleaning operations.
- Hydrocarbon refrigerant gas R290 for the lowest environmental impact (GWP=3) - CFC and HCFC free.
- Fin & Tube Condenser improves performance in high temperature environments.
- Automatic Defrost Cooling System provides worry-free performance.
- Heavy duty Vinyl coated steel shelves.
- High efficiency components to minimize the energy consumption still guaranteeing the highest performances.
- Cabinet and door insulated with high density polyurethane for low environmental impact.
- CFC and HCFC free, highly ecological refrigerant type: R290 (ecological gas in foam: cyclopentane). Hydrocarbon refrigerant gas R290 for the lowest environmental impact (GWP=3), to reduce green house and ozone depletion effects.
- Interior LED light to save energy and for best internal visibility.

Construction

- Lockable door.
- Electronic control to select temperatures.
- Pre-wired heavy duty power cord.
- Heavy duty door hinges.
- Magnetic door gasket removable without tools for easy cleaning.

Optional Accessories

- shelf clips PNC 880611

APPROVAL: _____

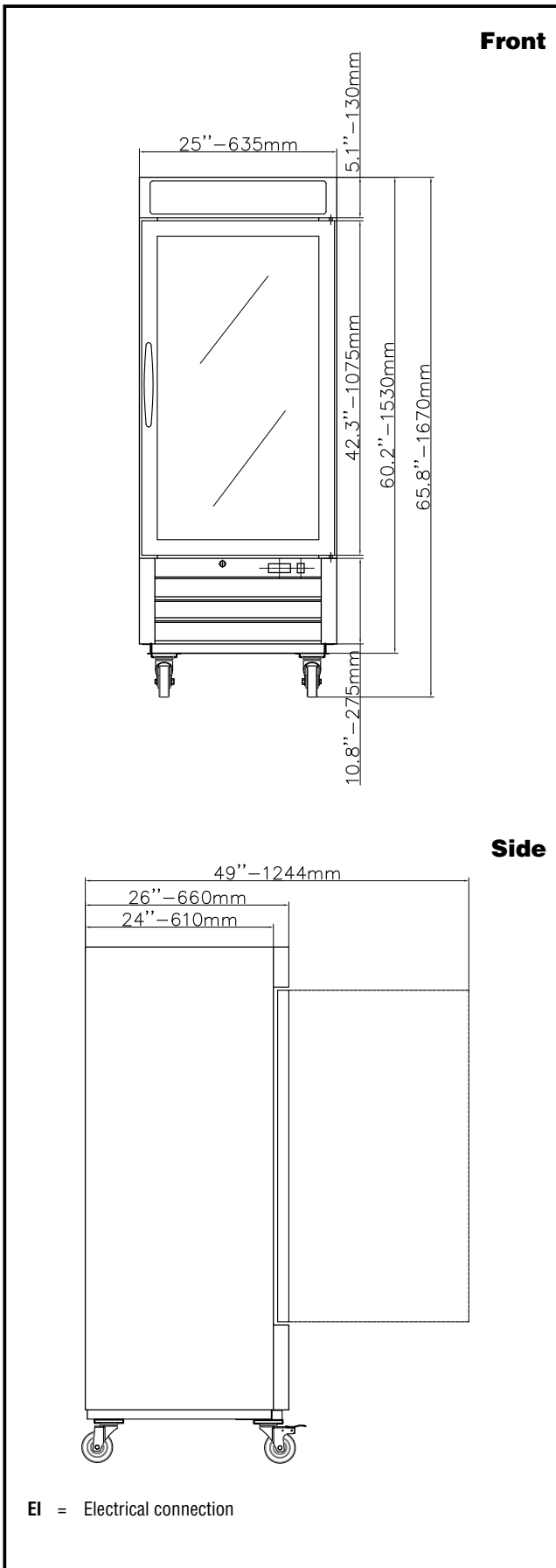

Electric

Supply voltage:	
738247 (KCHGM12R)	115 V/1 ph/60 Hz
Electrical power, max:	0.3 kW
Current consumption:	3 Amps
Plug type:	USA NEMA 5-15P

Key Information:

Capacity (Cu.Ft.)	12
Door hinges:	Right Side
External dimensions, Width:	25 " (635 mm)
External dimensions, Depth:	26 " (660 mm)
External dimensions, Height:	65 3/4" (1670 mm)
Number and type of doors:	1 Glass
Internal Dimensions (depth):	18 5/16"
Internal Dimensions (height):	46 1/16"
Internal Dimensions (width):	18 7/8"
Number and type of grids (included):	4 - Vinyl-Coated Steel
Shipping height:	68 11/16" (1745 mm)
Shipping weight:	254 lbs (115 kg)
Shipping volume:	30.57 ft ³ (0.87 m ³)
Type of external material:	Black Prepainted Steel
Type of internal material:	White Prepainted Aluminium
Warranty:	3 / 5 years

Refrigeration Data

Compressor Horsepower:	1/5
Refrigerant type:	R290
Refrigerant weight:	85 g
Operating temperature min.:	32 °F
Operating temperature max.:	41 °F
Condenser type:	Fin & tube
Defrost type:	Auto Defrost