



MAXX COLD X-series

CHEF BASE REFRIGERATORS

Service, Installation and Care Manual

Please read this manual completely before attempting to install or operate this equipment.
Notify carrier of damage! Inspect all components immediately.



English November 2016

PLEASE READ THESE INSTRUCTIONS CAREFULLY BEFORE USE AND SAVE THESE INSTRUCTIONS



CONTENTS

RECEIVING & INSPECTING EQUIPMENT.....	2
SPECIFICATIONS.....	3
INSTALLATION.....	4
OPERATION.....	5
MAINTENANCE.....	7
SAFETY PRECAUTIONS.....	9
ELECTRICAL WARNING.....	9
TROUBLE SHOOTING.....	10
WIRING DIAGRAM.....	11

All rights reserved. Reproduction without written permission is prohibited.

SERIAL NUMBER INFORMATION

The serial number of all self-contained refrigerators is located outside the unit on the left hand side near the top on the wall. Always have the serial number of your unit available when calling for parts or service.

This manual covers standard units only. If you have a custom unit, consult the customer service department at the number listed on the last page.

RECEIVING AND INSPECTING THE EQUIPMENT

Even though most equipment is shipped crated, care should be taken during unloading so the equipment is not damaged while being moved into the building.

1. Visually inspect the exterior of the package and skid or container. Any damage should be noted and reported to the delivering carrier immediately.
2. If damaged, open and inspect the contents with the carrier.
3. In the event that the exterior is not damaged, yet upon opening, there is concealed damage to the equipment, notify the carrier. Notification should be made verbally as well as in written form.
4. Request an inspection by the shipping company of the damaged equipment. This should be done within 10 days from receipt of the equipment.
5. Be certain to check the compressor compartment housing and visually inspect the refrigeration package. Be sure lines are secure and base is still intact.
6. Freight carriers can supply the necessary damage forms upon request.
7. Retain all crating material until an inspection has been made or waived.



MAXX COLD

X-series

Service and Installation Manual

SPECIFICATION

Chef Base Refrigerators								
MODEL#	V/Hz/Ph	AMPS	STORAGE CAPACIT	HP	BTU	CHARGE OZ	SHIP WEIGHT LBS	NEMA PLUG
MXCB48	115/60/1	5.8	6.5	1/3	3200	9.5	162	5-15P
MXCB60	115/60/1	5.8	8.8	1/3	3200	10.6	200	5-15P
MXCB72	115/60/1	5.8	11.1	1/3	5800	12.3	232	5-15P

NOTICE:

LOSS OR SPOILAGE OF PRODUCTS IN YOUR REFRIGERATOR/FREEZER IS NOT COVERED BY WARRANTY. IN ADDITION TO FOLLOWING RECOMMENDED INSTALLATION PROCEDURES. PLEASE RUN THE REFRIGERATOR/FREEZER 24 HOURS PRIOR TO USAGE. THANK YOU.

MAXX COLD X-series

Service and Installation Manual

INSTALLATION

Location

Units represented in this manual are intended for indoor use only. Be sure the location chosen has a floor strong enough to support the total weight of the cabinet and contents. A fully loaded unit can weigh as much as 1500 pounds. Reinforce the floor as necessary to provide for maximum loading. For the most efficient refrigeration, be sure to provide good air circulation inside and out.

Inside cabinet

Do not pack the units so full that air cannot circulate. The refrigerated air is discharged at the rear of the unit. It is important to allow for proper air flow from the rear to the front of the unit. Obstructions to this air flow can cause evaporator coil freeze ups and loss of temperature or overflow of water from the evaporator drain pan. However, bags and other items can still be located to the far rear of the cabinet. Air is brought into the evaporator coil with fans. Prevent obstruction to allow the outlet or inlet of air flow.

Outside cabinet

Be sure that the unit has access to ample air. Avoid hot corners and locations near stoves and ovens. It is recommended that the unit be installed no closer than 2" from any wall

Leveling

A level cabinet looks better and will perform better because the doors will line up with the frames properly. Use a level to make sure the unit is level from front to back and side to side. Units supplied with legs will have adjustable bullet feet to make the necessary adjustments. If the unit is supplied with casters, no adjustments are available. Ensure the floor where the unit is to be located is level.

Stabilizing

All models are supplied with casters for your convenience. It is very important, however, that the cabinet be installed in a stable condition with the front wheels locked while in use. Should it become necessary to lay the unit on its side or back for any reason, allow at least 24 hours before start-up to allow compressor oil to flow back to place. Failure to meet this requirement can cause compressor failure and unit damage.



Unit repairs will not be subject to standard unit warranties if due to improper installation procedures.

Electrical connection

Refer to the amperage data on page 3, the serial tag, your local code or the National Electrical Code to be sure the unit is connected to the proper power source.



The unit must be turned OFF and disconnected from the power source whenever performing service, maintenance functions or cleaning the refrigerated area.

MAXX COLD X-series

Service and Installation Manual

OPERATION



CAUTION

Do not throw items into the storage area. Failure to heed these recommendations could result in damage to the interior of the cabinet.

Refrigerated cabinets

Temperature range for the internal cabinets is 34°F to 38°F for the chef base refrigerators.

Food Prep units should operate with pans in place. Operating without pans and/or pan covers in place will lower the efficiency and may damage the unit due to continuous over-use.

Continuous opening and closing of the door will prevent the unit's ability to maintain optimum refrigeration temperature.

Defrosting:

Every 6 hours, the unit will turn off so the evaporator coil can defrost. The controller now displays the defrost symbol. When the coil temperature reaches the terminal temperature or after 20 minutes of defrost, the unit will turn on.

SOLID-STATE THERMOSRAT DESCRIPTIONS

1. FRONT PANEL COMMANDS





SET: To display target set point; in programming mode it selects a parameter or confirms an operation.

 (DEF) To start a manual defrost

 (UP) To view the last alarm occurrence; in programming mode, it browses the parameter codes or increases the display value

 (DOWN) To view the last alarm occurrence; in programming mode, it browses the parameter codes or decreases the display value

KEY COMBINATION

 +  To lock & unlock the keyboard







SET +  To enter in programming mode

SET +  To return to the room temperature display

MAXX COLD X-series

Service and Installation Manual

1.1 Function of LEDs

LED	MODE	FUNCTION
	ON	Compressor enabled
	Flashing	- Programming Phase (flashing with  - Anti-short cycle delay enabled
	ON	Defrost enabled
	Flashing	- Programming Phase (flashing with  - Drip time in progress
	ON	An temperature alarm happened



2. MAIN FUNCTIONS

2.1 HOW TO SEE THE SETPOINT

1. Push and immediately release the **SET** key: the display will show the set point value.
2. Push and immediately release the **SET** key or wait for 5 seconds to display the sensor value again.



2.2 HOW TO CHANGE THE SETPOINT



1. Push the **SET** key for more than 2 seconds to change the set point value.
2. The value of the set point will be displayed and the  LED starts blinking.
3. To change the set value push the  or  key within 10s.
4. To set new point value, push the SET key again or wait 10s.

2.3 HOW TO START A MANUAL DEFFROST

Push the  key for more than 2 seconds and a manual defrost will start





2.4 HOW TO LOCK THE KEYBOARD

1. Hold the  and  keys for more than 3s.
2. The "POF" message will be displayed and the keyboard will be locked. At this point, it will be possible only to see the set point or the MAX or Min temperature stored.
3. If a key is pressed more than 3s the "POF" message will be displayed.





2.5 HOW TO UNLOCK THE KEYBOARD

Hold the  and  keys together for more than 3s, till the "POF" message is displayed.

3. ALARM SIGNALS

HOW TO SEE THE ALARM AND RESET THE RECORDED ALARM

1. Hold the  or  key to display the alarm signals.
2. When the signal is displayed, hold the **SET** key until the "rst" message is displayed. Push the **SET** key again. The "rst" message will start blinking and the normal temperature will be displayed again.

Message	Cause	Outputs
"P1"	Room probe failure	Compressor output according to par. "Con" and "COF"
"P2"	Evaporator probe failure	Defrost end is timed
"HA"	Maximum temperature alarm	Outputs unchanged.
"LA"	Minimum temperature alarm	Outputs unchanged.
"dA"	Door open	Regulation restarts
"EA"	External alarm	Output unchanged.
"CA"	Serious external alarm (i1F=bAL)	All outputs OFF.
"CA"	Pressure switch alarm (i1F=PAL)	All outputs OFF

MAXX COLD X-series

Service and Installation Manual

MAINTENANCE



NEVER USE STEEL PADS, WIRE BRUSHES OR SCRAPERS!

Cleaning solutions need to be alkaline based or non-chloride based. Any cleaner containing chlorides will damage the protective film of the stainless steel. Chlorides are commonly found in hard water, salts, and household and industrial cleaners. If cleaners containing chlorides are used, be sure to rinse and dry thoroughly.

Routine cleaning of stainless steel can be done with soap and water. Extreme stains or grease should be cleaned with a non-abrasive cleaner and plastic scrub pad. It is always good to rub with the grain of the steel. There are also stainless steel cleaners available which can restore and preserve the finish of the steels protective layer.

Early signs of stainless steel breakdown can consist of small pits and cracks. If this has begun, clean thoroughly and start to apply stainless steel cleaners in attempt to restore the passivity of the steel.



Never use an acid based cleaning solution! Many food products have an acidic content which can deteriorate the finish. Be sure to clean the stainless steel surfaces of ALL food products.

Gasket Maintenance

Gaskets require regular cleaning to prevent mold and mildew build up and also to keep the elasticity of the gasket. Gasket cleaning can be done with the use of warm soapy water. Avoid full strength cleaning products on gaskets as this can cause them to become brittle and prevent proper seals. Do not use sharp tools or knives to scrape or clean the gasket which could possibly tear the gasket and rip the bellows.

Gaskets can easily be replaced and don't require the use of tools or authorized service technicians. The gaskets are "Dart" style and can be pulled out of the groove in the door and replaced by pressing the new one back into place.

Doors/Hinges

Over time and with heavy use, door hinges may become loose. If the door is beginning to sag, tighten the screws that mount the hinge brackets to the frame of the unit. If the doors are loose or sagging this can cause the hinge to pull out of the frame which may damage to both the doors and the door hinges.

Drain Maintenance

Each unit has a drain located inside the unit which removes the condensation from the evaporator coil and evaporates it into an external condensate evaporator pan. Each drain can become loose or disconnected from moving or bumping the drain. If you notice excessive water accumulation on the inside of the unit, be sure the drain tube is connected from the evaporator housing to the condensate evaporator drain pan. If water starts to collect underneath the unit, you may want to check the condensate evaporator drain tube to be sure it is still located inside the drain pan. The leveling of the unit is important as the units are designed to drain properly when on a level surface. If your floor is not level this can also cause drain problems. Be sure all drain lines are free of obstructions because this may cause water to back up and overflow the drain pans.

SAFETY PRECAUTIONS

- This refrigerator must be properly installed and located in accordance with the Installation Instructions before it is used.
- Do not allow children to climb, stand or hang on the shelves in the refrigerator. They could damage the refrigerator and seriously injure themselves.
- Do not touch the cold surfaces in the freezer compartment when hands are damp or wet. Skin may stick to these extremely cold surfaces.
- Do not store or use gasoline or other flammable vapors and liquids in the vicinity of this or any other appliance
- Keep fingers out of the "pinch point" areas; clearances between the doors and between the doors and cabinet are necessarily small; be careful closing doors when children are in the area.

NOTE: We strongly recommend that any servicing be performed by a qualified individual.

- Unplug the refrigerator before cleaning and making repairs.
- Setting temperature controls to the ZERO (0) position does not remove power to the light circuit, perimeter heaters, or evaporator fans.

Refrigerant Disposal

Your old refrigerator may have a cooling system that uses "Ozone Depleting" chemicals. If you are throwing away your old refrigerator, make sure the refrigerant is removed for proper disposal by a qualified service technician. If you intentionally release any refrigerants you can be subject to fines and imprisonment under provisions of the environmental regulations.

ELECTRICAL WARNING

- Please ensure that the required voltage is being supplied at all times.
- The unit should be plugged into a grounded and properly-sized electrical outlet with appropriate over-current protection. NEVER USE AN ADAPTER PLUG!
- The unit should have its own dedicated outlet.
- Do not use extension cords.
- Do not unplug your unit by pulling on the power cord. Grip the plug firmly and pull straight out from the outlet.
- Ensure the unit is not resting on or against the electrical cord.
- If the unit is not in use for a long period of time, best to unplug the unit from the outlet.
- To avoid shock and fire hazards, do not plug in or unplug the unit with wet hands.
- After unplugging the unit, wait at least 10 minutes before plugging it back in. Failure to do so could cause damage to the compressor.
- If the power cuts off, wait at least 5 minutes before turning the unit on to avoid damage to the compressor.



MAXX COLD

X-series

Service and Installation Manual

TROUBLE SHOOTING

Fault	Probable Cause	Action
Compressor is Not Running	Fuse blown or circuit breaker tripped	Replace fuse or reset circuit breaker.
	Power cord unplugged	Plug in power cord
	Thermostat set too high	Set thermostat to lower temperature
Cabinet Temperature is too Warm	Thermostat is set too high	Set thermostat to lower temperature.
	Airflow is blocked	Re-arrange products to allow for proper air flow. Make sure there is at least four inches of clearance from the fan
	Low refrigerant levels	Contact a service technician to check refrigerant levels
	Door is slightly ajar	Make sure door is completely closed.
Interior Light is Not Working	Poor switch connection	Turn off light switch and turn it back on.
	Bulb is not connected	Make sure the bulb is correctly inserted in the socket.
	Bulb has burned out	Replace the bulb
Condensation is Collecting on the Cabinet and/or Floor	Gasket is not sealing properly	Clean, repair, or replace the gasket as necessary

MAXX COLD X-series

Service and Installation Manual

WIRING DIAGRAM

MODEL: MXCB48/MXCB60

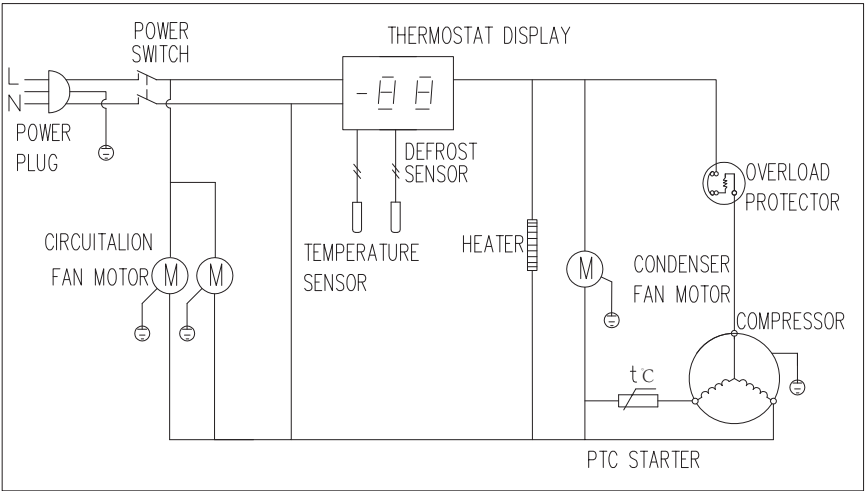

MODEL: MXCB72

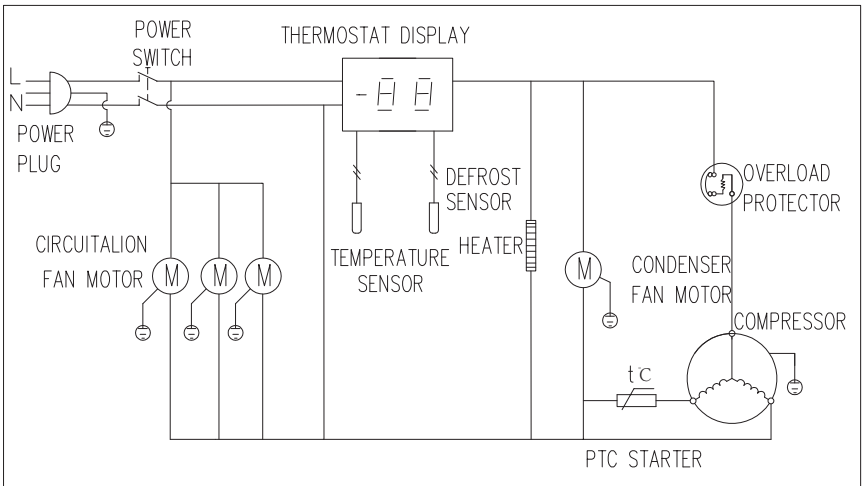

MAXX COLD X-series

WIRING DIAGRAM

MODEL: MXCB48/MXCB60/MXCB72

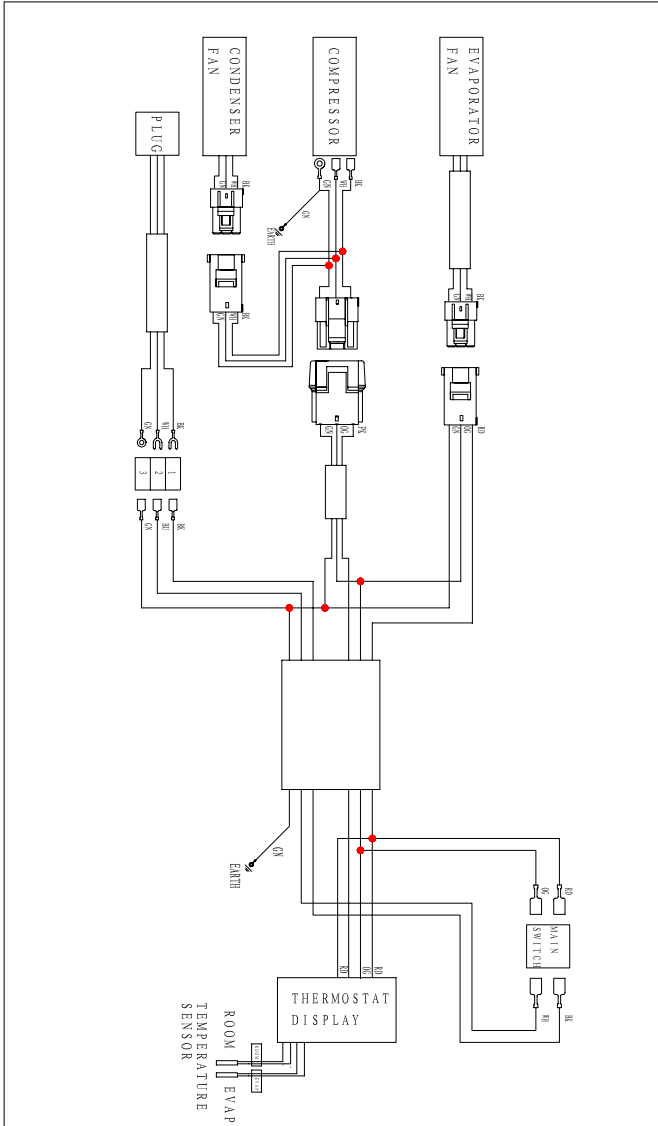



MAXX COLD
X-series

3355 Enterprise Ave., Suite 160 - Ft. Lauderdale, FL 33331

T: (954) 202-1419 - F: (954) 202-7336

www.maxximumfoodservice.com